



b.o.b. Sistemi Idraulici S.p.A.

italev

COMPANY
WITH QUALITY SYSTEM
CERTIFIED BY DNV
= ISO 9001/2000 =

ABROLLKIPPER « ITK 26/6 »

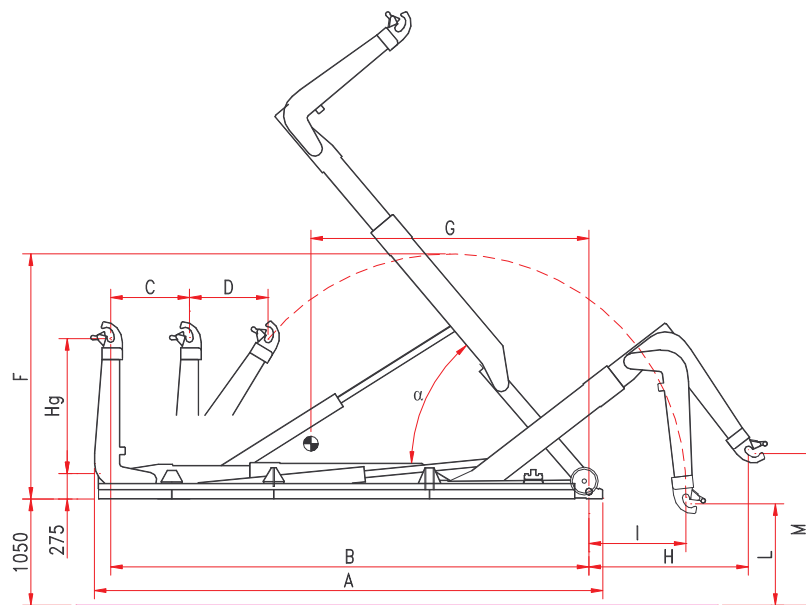

Modell	Hg	A	B	C	D	F	G	Gewicht	α	Behälter	min.	max.
ITK 26/6 C *	1.430/1.570	5.100	4.800	650	850	2.700	2.850	2.810 kg	58°		4.000	5.700
ITK 26/6 NC	1.430/1.570	5.300	5.000	850	850	2.700	2.900	2.810 kg	54°		4.200	5.900
ITK 26/6 N	1.430/1.570	5.500	5.200	850	850	2.700	3.000	2.840 kg	51°		4.400	6.100
ITK 26/6 NL	1.430/1.570	5.700	5.400	850	850	2.700	3.100	2.870 kg	48°		4.600	6.300
ITK 26/6 L	1.430/1.570	5.900	5.600	850	850	2.700	3.200	2.900 kg	45°	4.800	6.500	

* Sonderanfertigung

Die in dieser Zeichnung enthaltenen Daten sind unverbindlich und können jederzeit vom Hersteller geändert werden.

B.O.B. Sistemi Idraulici S.p.A. – Regione Oltre Rea, 61 – 12060 Monchiero (CN) - Italia
P. I.V.A. 00496180043 - Tel.: +39 (0173) 780002/3 – Fax: +39 (0173) 780004
Internet: www.bobspa.com - e-mail: info@bobitalev.com