



b.o.b. Sistemi Idraulici S.p.A.

italev

COMPANY
WITH QUALITY SYSTEM
CERTIFIED BY DNV
= ISO 9001/2000 =

ABROLLKIPPER « IT 18 »

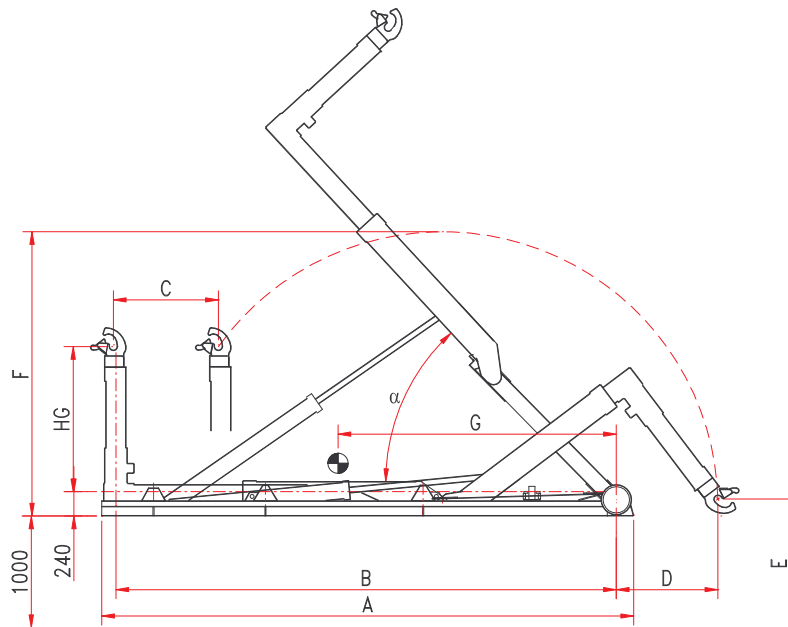

Modell	HG	A	B	C	D	E	F	G	Gewicht	α	Behälter	min.	max.
IT 18 C	1.430/1.570	4.820	4.520	1.032	1.400	1.150	2.800	2.200	2.050 kg	55°		4.000	5.500
IT 18 NC	1.430/1.570	5.020	4.720	1.032	1.200	1.150	2.800	2.250	2.080 kg	51°		4.200	5.700
IT 18 N	1.430/1.570	5.220	4.920	1.032	1.000	1.150	2.800	2.300	2.100 kg	47°		4.400	5.900
IT 18 NL	1.430/1.570	5.420	5.120	1.032	800	1.150	2.800	2.350	2.120 kg	45°	4.600	6.100	

Die in dieser Zeichnung enthaltenen Daten sind unverbindlich und können jederzeit vom Hersteller geändert werden.

B.O.B. Sistemi Idraulici S.p.A. – Regione Oltre Rea, 61 – 12060 Monchiero (CN) - Italia
P. I.V.A. 00496180043 - Tel.: +39 (0173) 780002/3 – Fax: +39 (0173) 780004
Internet: www.bobspa.com - e-mail: info@bobitalev.com