



b.o.b. Sistemi Idraulici S.p.A.

italev

COMPANY  
WITH QUALITY SYSTEM  
CERTIFIED BY DNV  
= ISO 9001/2000 =

HOOKLIFT « LIFT 6 »

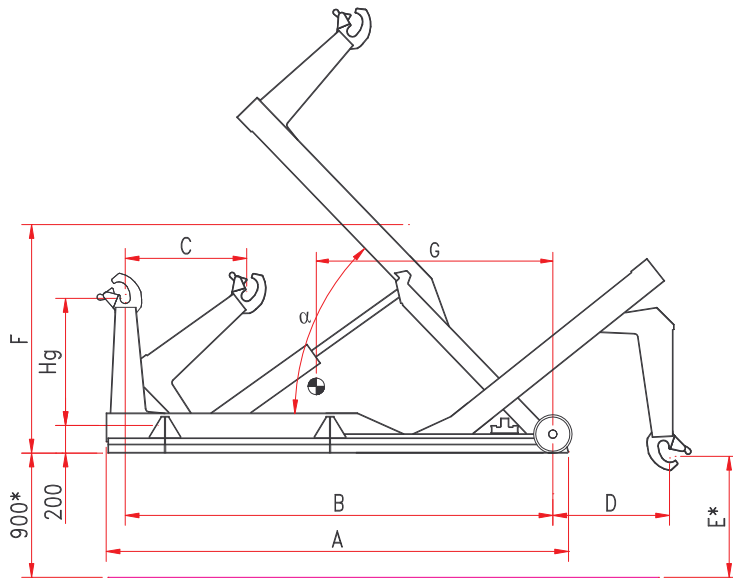

Model	Hg	A	B	C	D	E	F	G	Weight	$\alpha$	Container	min.	max.
LIFT 6 (920) C	900/920	3.165	2.950	885	935	875	1.655	1.750	890 kg	52°		3.200	3.500
LIFT 6 (920) N	900/920	3.365	3.150	885	735	875	1.655	1.800	920 kg	46°		3.300	3.800
LIFT 6 (920) L	900/920	3.565	3.350	885	535	875	1.655	1.850	950 kg	42°		3.500	4.000
LIFT 6 (920) XL	900/920	3.765	3.550	885	785	875	1.800	1.910	1.070 kg	52°		3.800	4.300
LIFT 6 (920) XXL	900/920	3.965	3.750	885	585	875	1.800	1.960	1.100 kg	47°	4.000	4.500	

The technical details shown in this sheet are indicative and can be changed by the builder without prior notice.

**B.O.B. Sistemi Idraulici S.p.A.** – Regione Oltre Rea, 61 – 12060 Monchiero (CN) - Italia  
P. I.V.A. 00496180043 - Tel.: +39 (0173) 780002/3 – Fax: +39 (0173) 780004  
Internet: [www.bobspa.com](http://www.bobspa.com) - e-mail: [info@bobitalev.com](mailto:info@bobitalev.com)