



b.o.b. Sistemi Idraulici S.p.A.

italev

COMPANY
WITH QUALITY SYSTEM
CERTIFIED BY DNV
= ISO 9001/2000 =

HOOKLIFT « LIFT 8 »

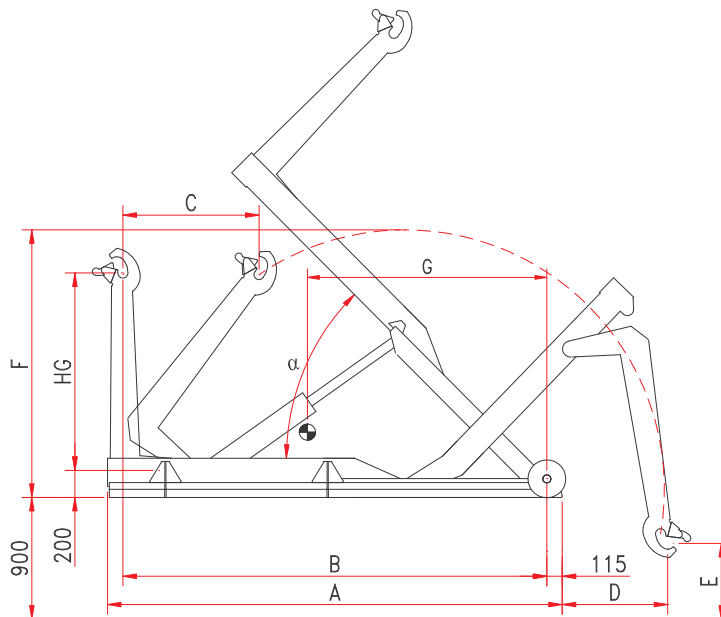

Model	HG	A	B	C	D	E	F	G	Weight	α	Container	min.	max.
LIFT 8 C	1.430/1.570	3.165	2.950	1.000	975	590	1.980	1.750	920 kg	52°		3.200	3.500
LIFT 8 N	1.430/1.570	3.365	3.150	1.000	775	590	1.980	1.800	950 kg	46°		3.300	3.800
LIFT 8 L	1.430/1.570	3.565	3.350	1.000	575	590	1.980	1.850	980 kg	42°		3.500	4.000
LIFT 8 XL	1.430/1.570	3.765	3.550	1.000	835	400	2.190	1.910	1.100 kg	52°		3.800	4.300
LIFT 8 XXL	1.430/1.570	3.965	3.750	1.000	635	400	2.190	1.960	1.130 kg	47°		4.000	4.500

The technical details shown in this sheet are indicative and can be changed by the builder without prior notice.

B.O.B. Sistemi Idraulici S.p.A. – Regione Oltre Rea, 61 – 12060 Monchiero (CN) - Italia
P. I.V.A. 00496180043 - Tel.: +39 (0173) 780002/3 – Fax: +39 (0173) 780004
Internet: www.bobspa.com - e-mail: info@bobitalev.com