



b.o.b. Sistemi Idraulici S.p.A.

italev

COMPANY
WITH QUALITY SYSTEM
CERTIFIED BY DNV
= ISO 9001/2000 =

HOOKLIFT « IT 20/7 »

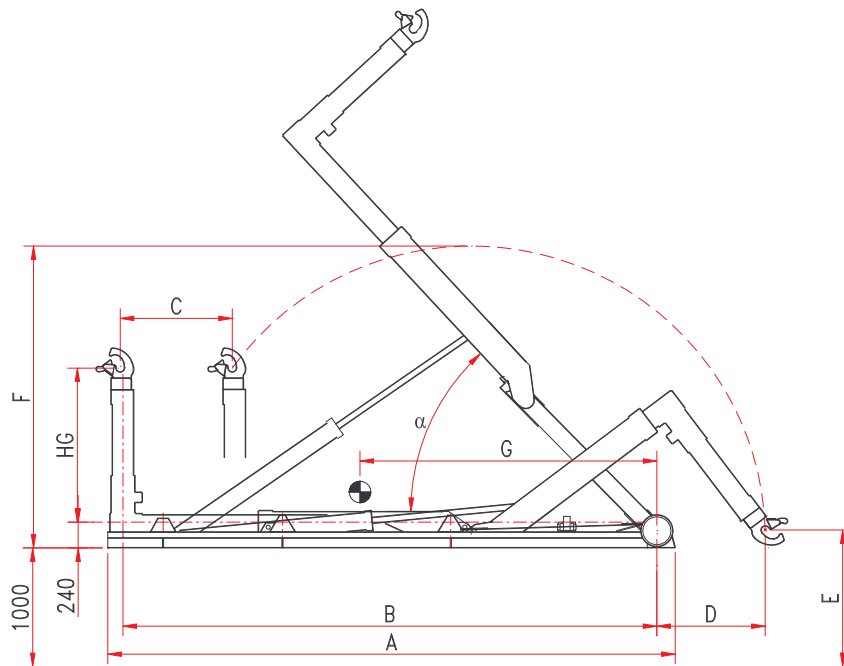

Model	HG	A	B	C	D	E	F	G	Weight	α	Container	min.	max.
IT 20/7U C	1.430/1.570	5.985	5.730	1.300	1.480	1.220	3.290	3.200	2.950 kg	54°		4.800	6.800
IT 20/7U NC	1.430/1.570	6.185	5.930	1.300	1.280	1.220	3.290	3.350	3.000 kg	51°		5.000	7.000
IT 20/7U N	1.430/1.570	6.385	6.130	1.300	1.080	1.220	3.290	3.500	3.050 kg	48°		5.200	7.200
IT 20/7U NL	1.430/1.570	6.585	6.330	1.300	880	1.220	3.290	3.650	3.100 kg	46°		5.400	7.400
IT 20/7U L	1.430/1.570	6.785	6.530	1.300	680	1.220	3.290	3.800	3.150 kg	44°	5.600	7.600	

The technical details shown in this sheet are indicative and can be changed by the builder without prior notice.

B.O.B. Sistemi Idraulici S.p.A. – Regione Oltre Rea, 61 – 12060 Monchiero (CN) - Italia
P. I.V.A. 00496180043 - Tel.: +39 (0173) 780002/3 – Fax: +39 (0173) 780004
Internet: www.bobspa.com - e-mail: info@bobitalev.com