



b.o.b. Sistemi Idraulici S.p.A.

italev

COMPANY
WITH QUALITY SYSTEM
CERTIFIED BY DNV
= ISO 9001/2000 =

BRAS DE LEVAGE « IT 8 »

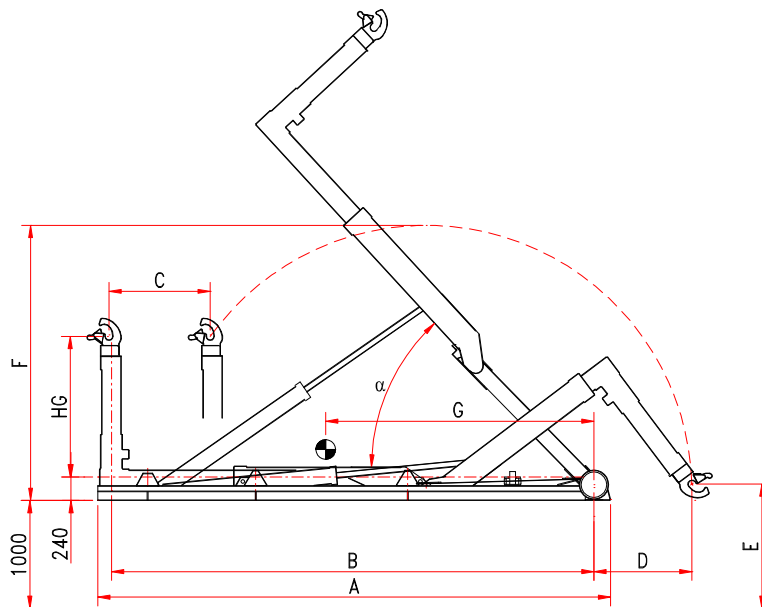

Modèle	HG	A	B	C	D	E	F	G	Poids	a	Conteneur	min.	max.
IT 8 C	1.425/1.570	4.135	3.850	800	1.400	1.145	2.600	2.200	1.580 kg	58°		3.500	4.500
IT 8 N	1.425/1.570	4.335	4.050	800	1.200	1.145	2.600	2.250	1.600 kg	53°		3.800	4.800
IT 8 NL	1.425/1.570	4.535	4.250	800	1.000	1.145	2.600	2.300	1.630 kg	49°		4.100	5.100
IT 8 L	1.425/1.570	4.735	4.450	800	800	1.145	2.600	2.350	1.650 kg	45°	4.400	5.400	

Les données de la présente fiche technique sont indicatives et peuvent être changées par le constructeur sans préavis.

B.O.B. Sistemi Idraulici S.p.A. – Regione Oltre Rea, 61 – 12060 Monchiero (CN) - Italia
P. I.V.A. 00496180043 - Tel.: +39 (0173) 780002/3 – Fax: +39 (0173) 780004
Internet: www.bobspa.com - e-mail: info@bobitalev.com