



b.o.b. Sistemi Idraulici S.p.A.

italev

COMPANY
WITH QUALITY SYSTEM
CERTIFIED BY DNV
= ISO 9001/2000 =

BRAS DE LEVAGE « IT 20/6 »

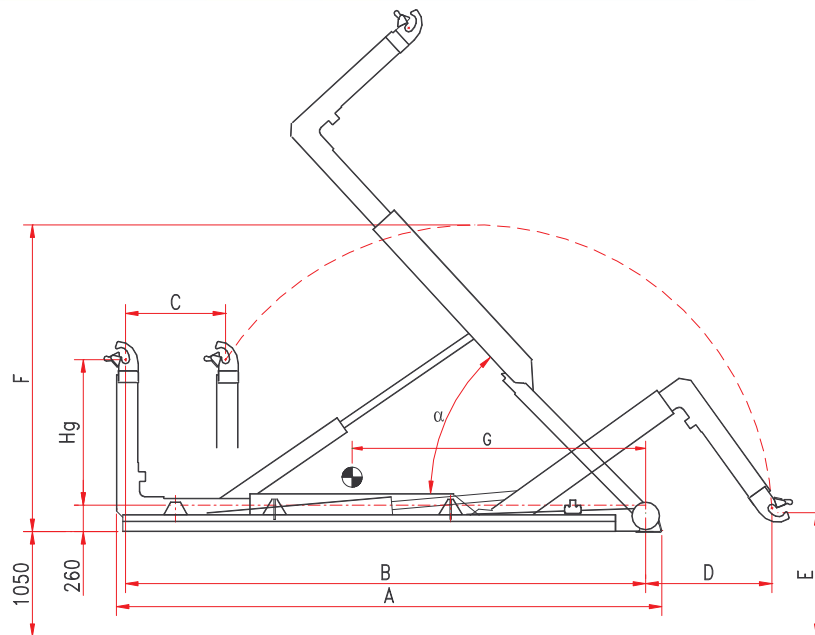

Modèle	HG	A	B	C	D	E	F	G	Poids	α	Conteneur	min.	max.
IT 20/6U XC	1.430/1.570	4.845	4.590	800	1.860	1.240	3.070	2.600	2.400 kg	55°		4.200	5.500
IT 20/6U C	1.430/1.570	5.045	4.790	1.000	1.660	1.240	3.070	2.600	2.450 kg	55°		4.200	5.700
IT 20/6U NC	1.430/1.570	5.245	4.990	1.000	1.460	1.240	3.070	2.750	2.500 kg	51°		4.400	5.900
IT 20/6U N	1.430/1.570	5.445	5.190	1.000	1.260	1.240	3.070	2.900	2.550 kg	48°		4.600	6.100
IT 20/6U NL	1.430/1.570	5.645	5.390	1.000	1.060	1.240	3.070	3.050	2.600 kg	45°		4.800	6.300
IT 20/6U L	1.430/1.570	5.845	5.590	1.000	860	1.240	3.070	3.200	2.650 kg	42°		5.000	6.500

Les données de la présente fiche technique sont indicatives et peuvent être changées par le constructeur sans préavis.

B.O.B. Sistemi Idraulici S.p.A. – Regione Oltre Rea, 61 – 12060 Monchiero (CN) - Italia
P. I.V.A. 00496180043 - Tel.: +39 (0173) 780002/3 – Fax: +39 (0173) 780004
Internet: www.bobspa.com - e-mail: info@bobitalev.com