

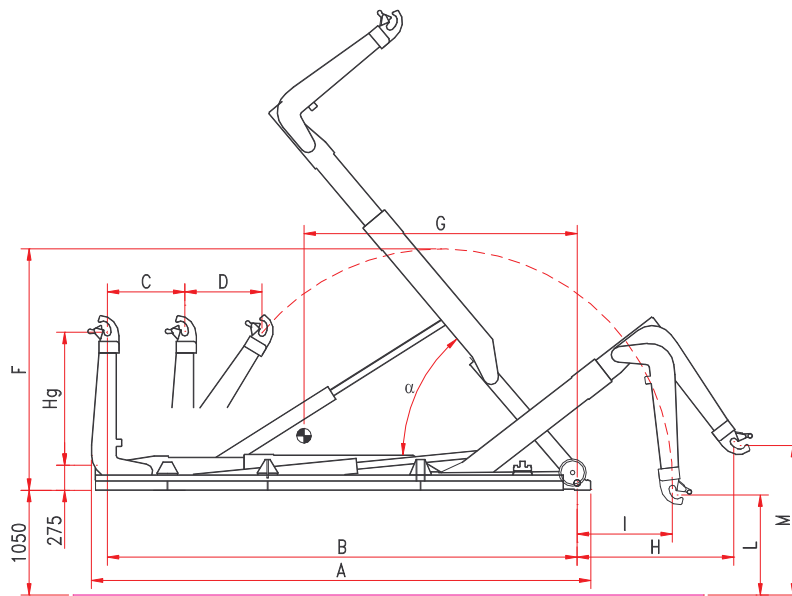

b.o.b. Sistemi Idraulici S.p.A.

COMPANY
WITH QUALITY SYSTEM
CERTIFIED BY DNV
= ISO 9001/2000 =

ATTREZZATURA SCARRABILE « ITK 26/7 »



Modello	Hg	A	B	C	D	F	G	Peso	α	Contenitore	min.	max.
ITK 26/7 C	1.430/1.570	6.150	5.750	1.150	850	2.890	3.400	3.010 kg	57°		4.700	6.700
ITK 26/7 NC	1.430/1.570	6.350	5.950	1.150	850	2.890	3.500	3.040 kg	53°		4.900	6.900
ITK 26/7 N	1.430/1.570	6.550	6.150	1.150	850	2.890	3.600	3.070 kg	51°		5.100	7.100
ITK 26/7 NL	1.430/1.570	6.750	6.350	1.150	850	2.890	3.700	3.100 kg	48°		5.300	7.300
ITK 26/7 L	1.430/1.570	6.950	6.550	1.150	850	2.890	3.800	3.130 kg	45°	5.500	7.500	

I dati contenuti nella presente scheda tecnica sono indicativi e possono essere modificati dal costruttore senza preavviso.

B.O.B. Sistemi Idraulici S.p.A. – Regione Oltre Rea, 61 – 12060 Monchiero (CN) - Italia
P. I.V.A. 00496180043 - Tel.: +39 (0173) 780002/3 – Fax: +39 (0173) 780004
Internet: www.bobspa.com - e-mail: info@bobitalev.com